

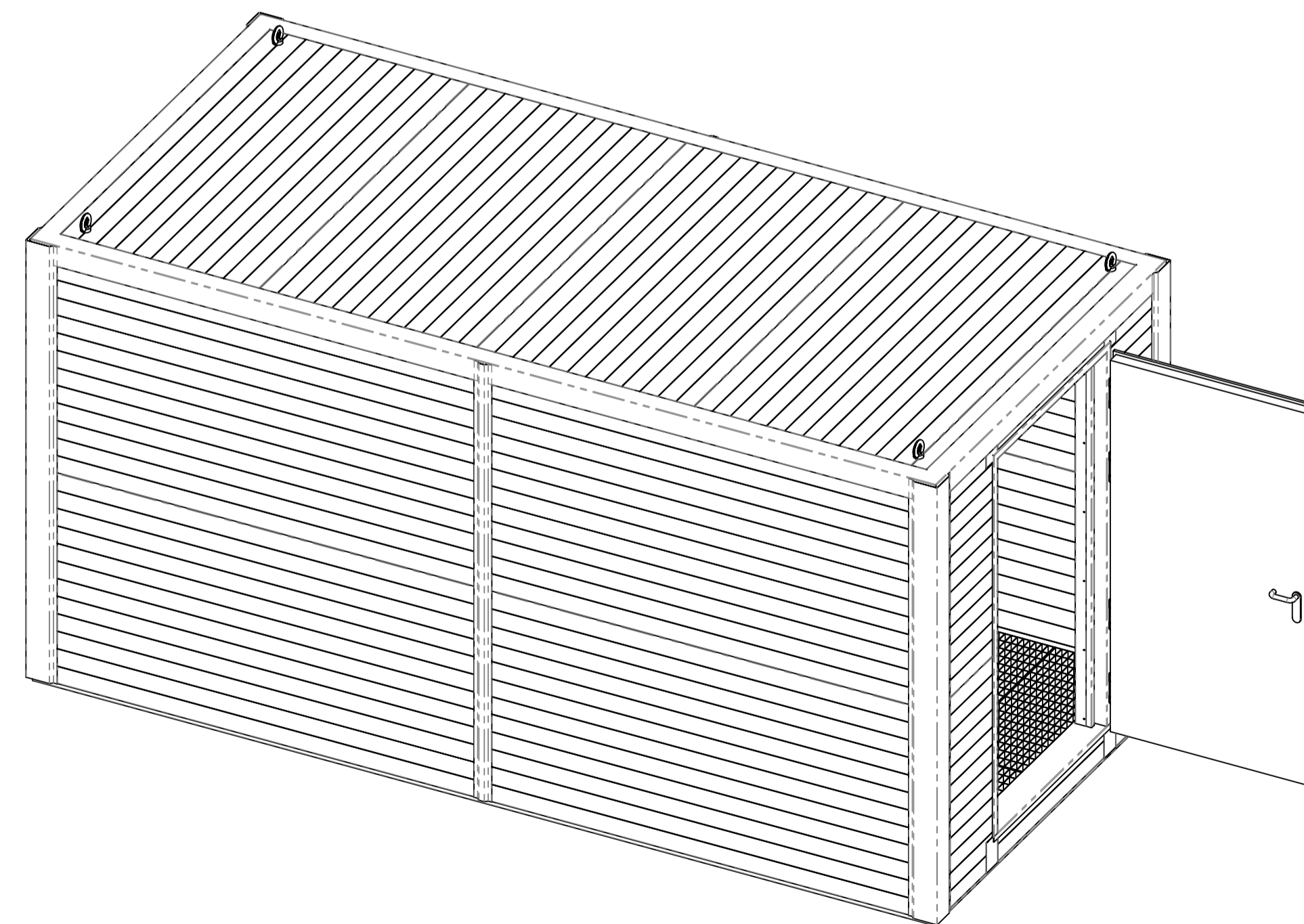

SECTION B-B
SCALE 1 : 25

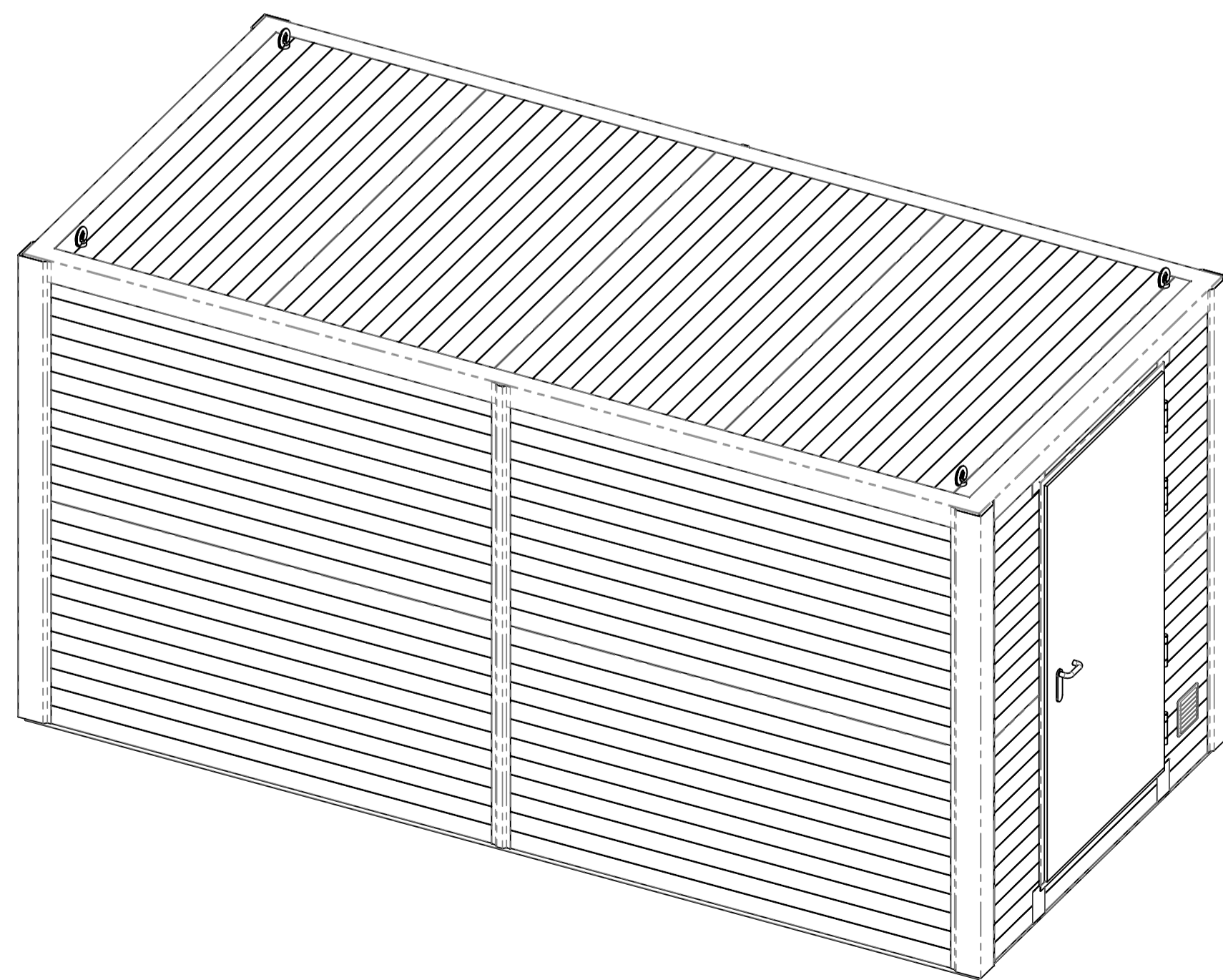
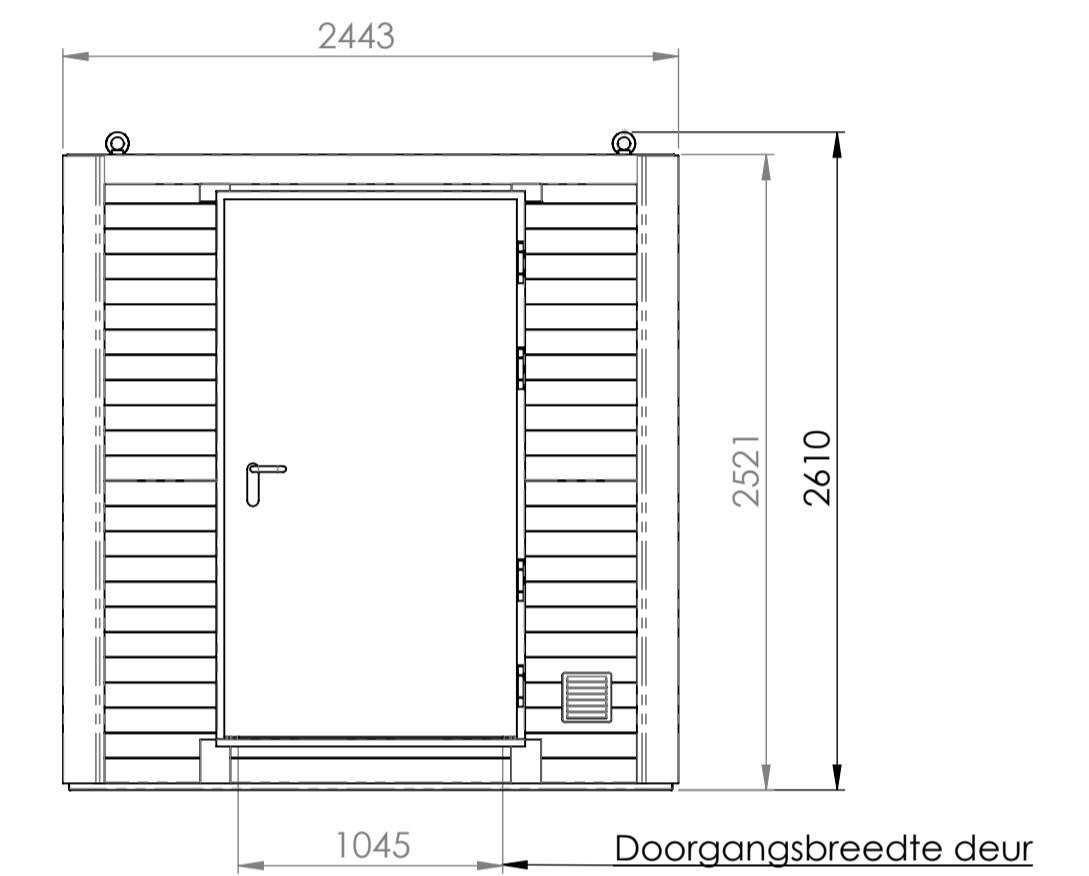
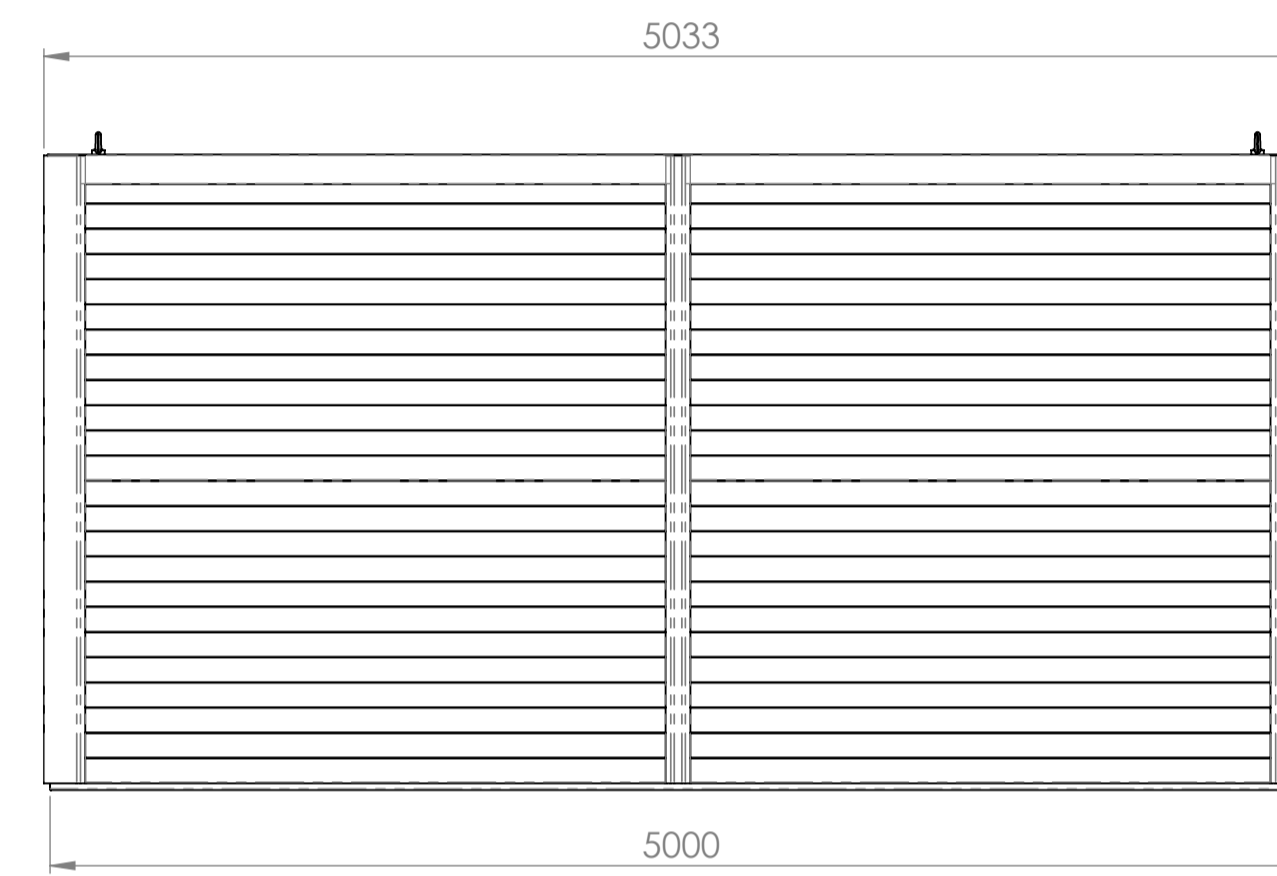
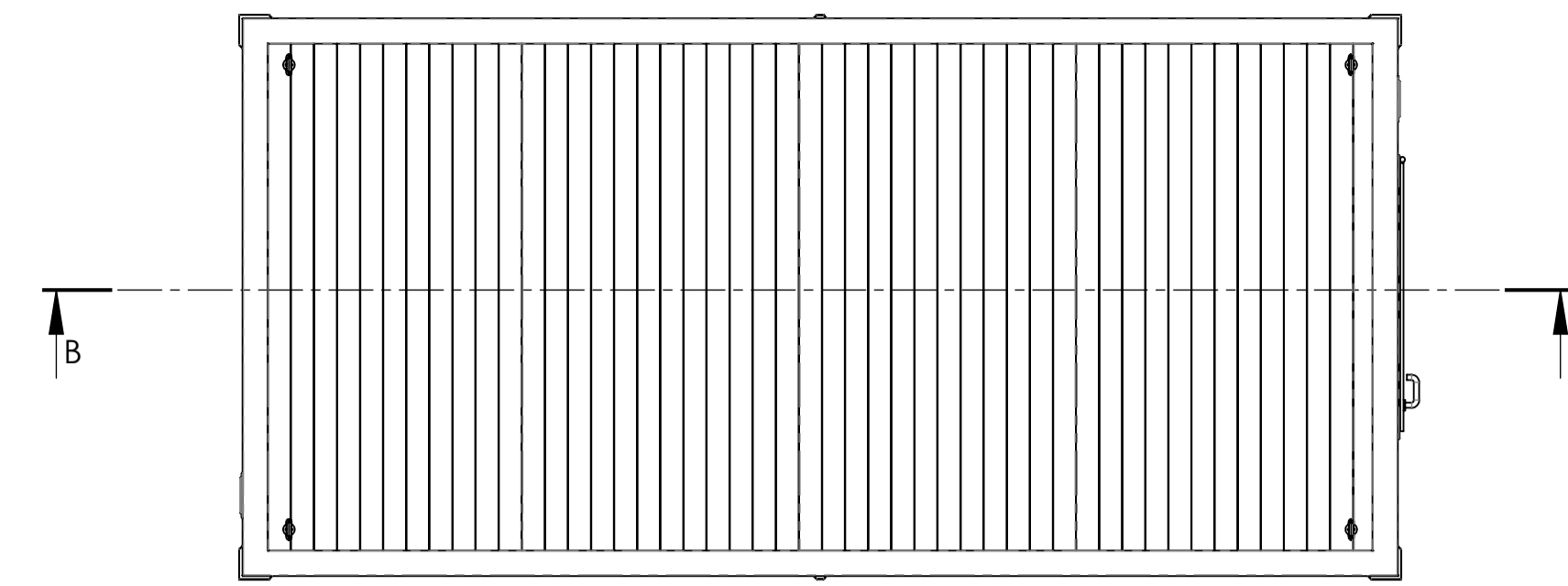

MS-502425
Inwendige afmeting:
(BxDxH) 4840x2250x2240

COPYRIGHT: ZONDER TOESTEMMING VAN HILTRA BARNEVELD IS VERSPREIDING IN WELKE VORM DAN OOK VERBODEN		Tenzij anders vermeld: Maten in mm	
Project: MS serie		Toleranties volgens DIN 7168-M	
Onderwerp: MS5 unit 5000x2410x2630		Wijziging rapport nr.	Tek. nr.: MS5-60-SA-A242
		REV.: A	16-1-2015
		Offertenr.:	...
		Ordernr.:	...
		Hiltra Barneveld B.V. Compagnieweg 14-16 3771 NH BARNEVELD	Tel.: 0342-404160 Fax.: 0342-404169 www.hiltra.com
		Formaat: A1	Schaal: 1:30
		Sheet: 1/2	
		Getekend: JB	4-9-2014