

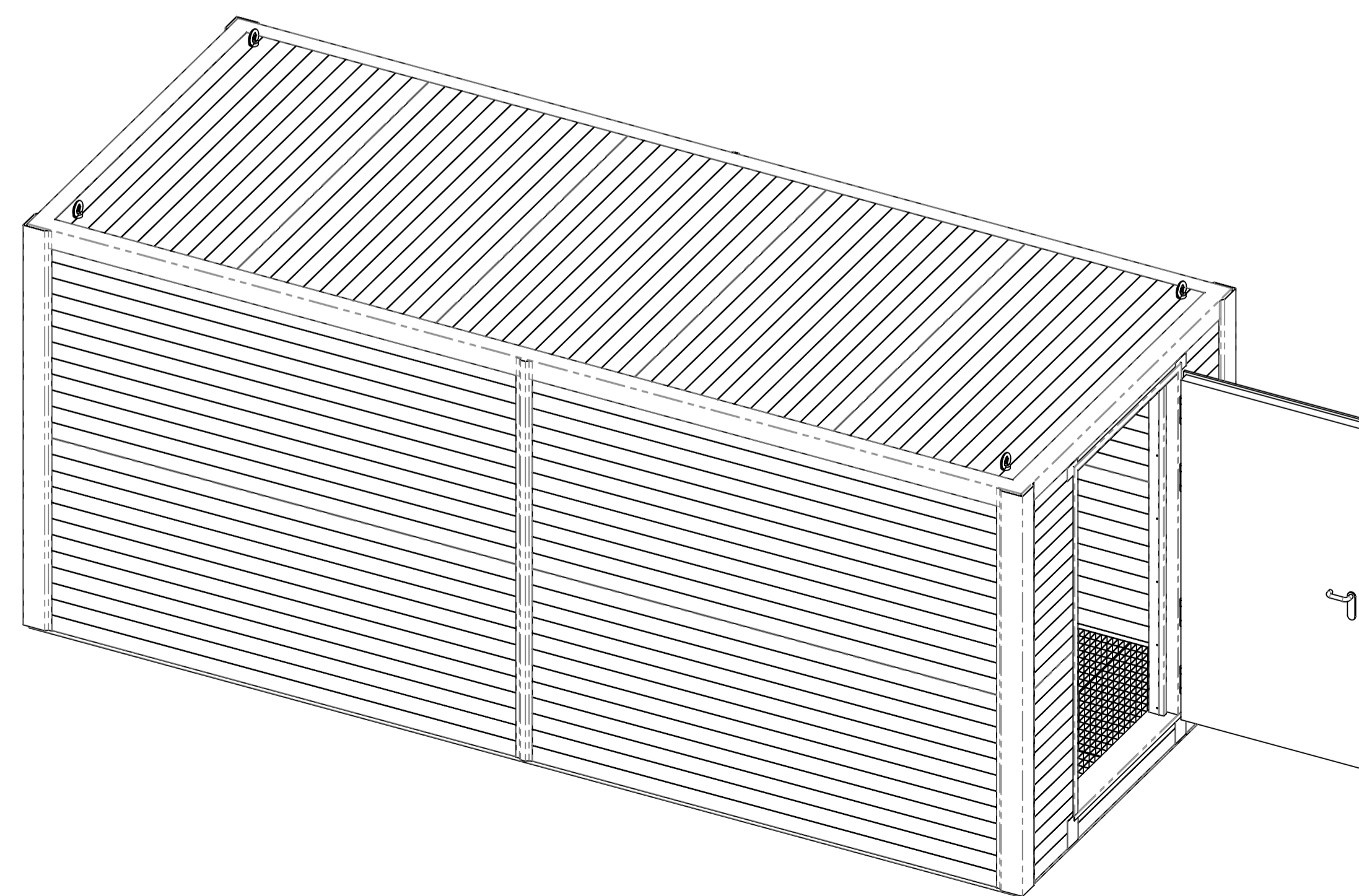

SECTION B-B
SCALE 1 : 25

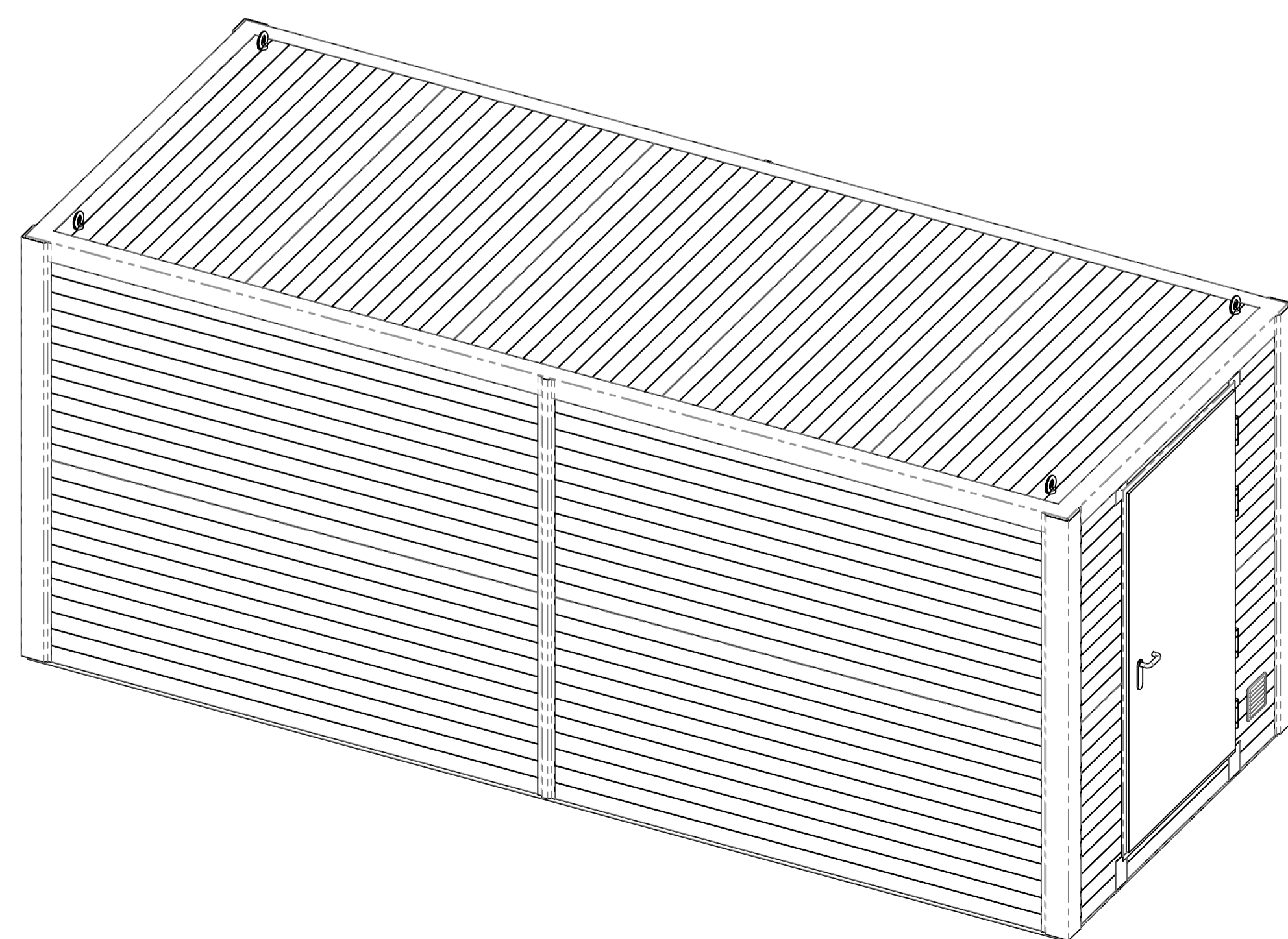
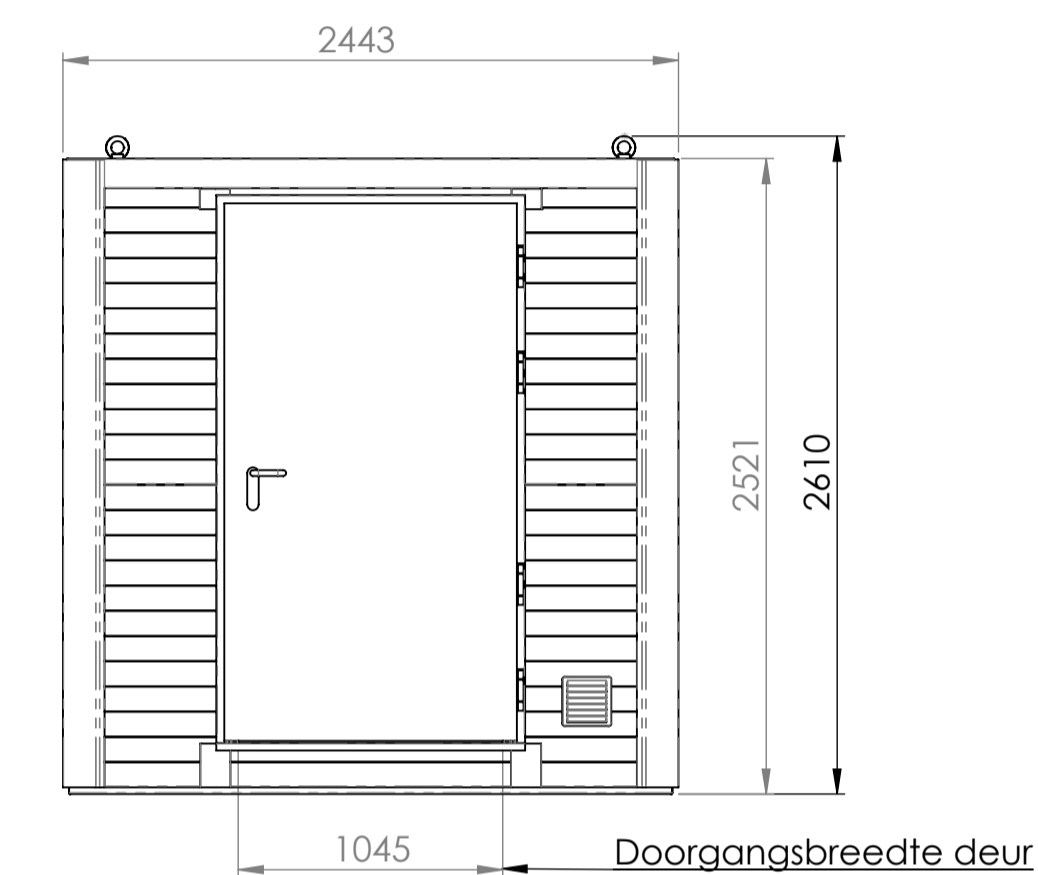
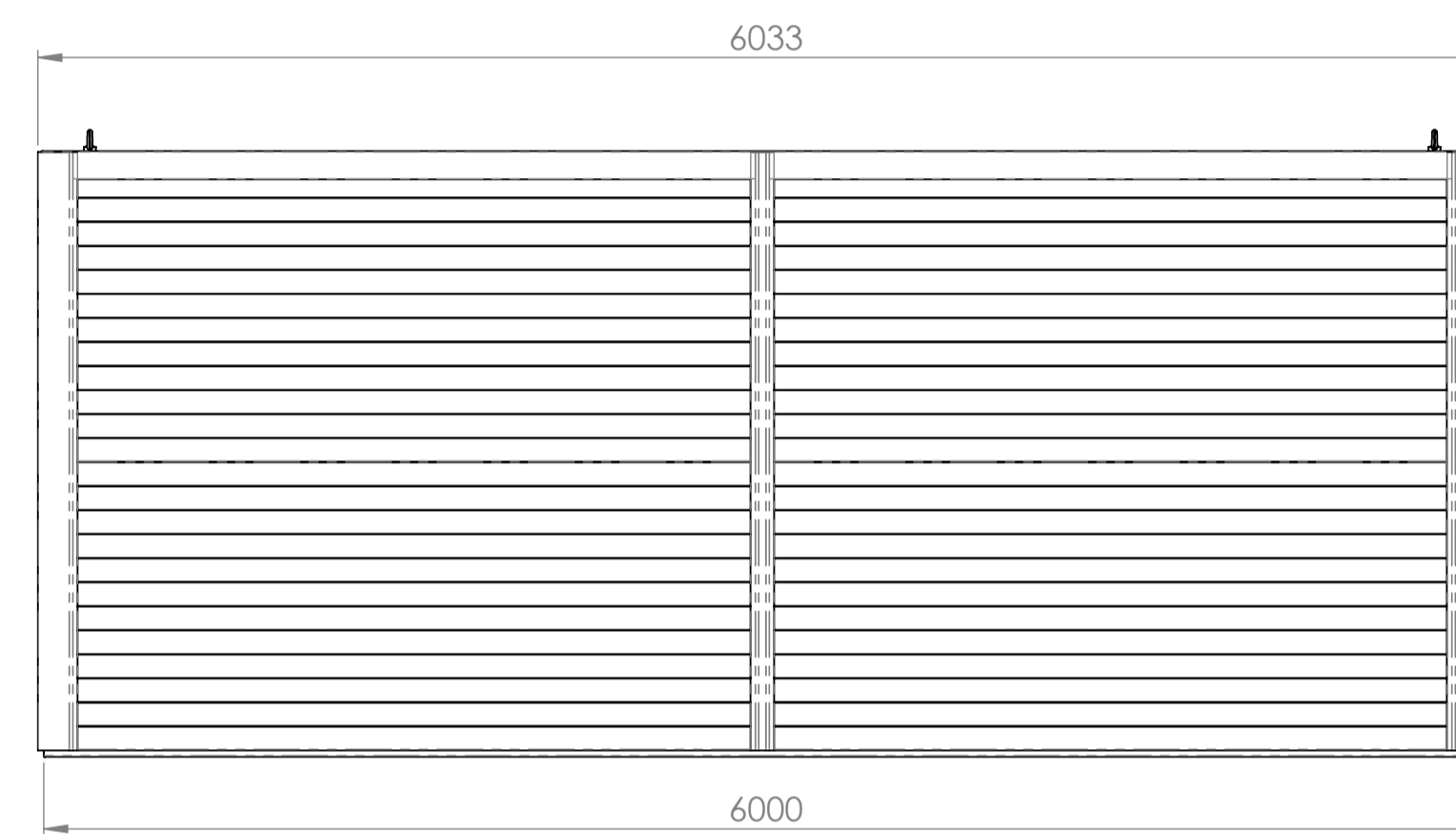
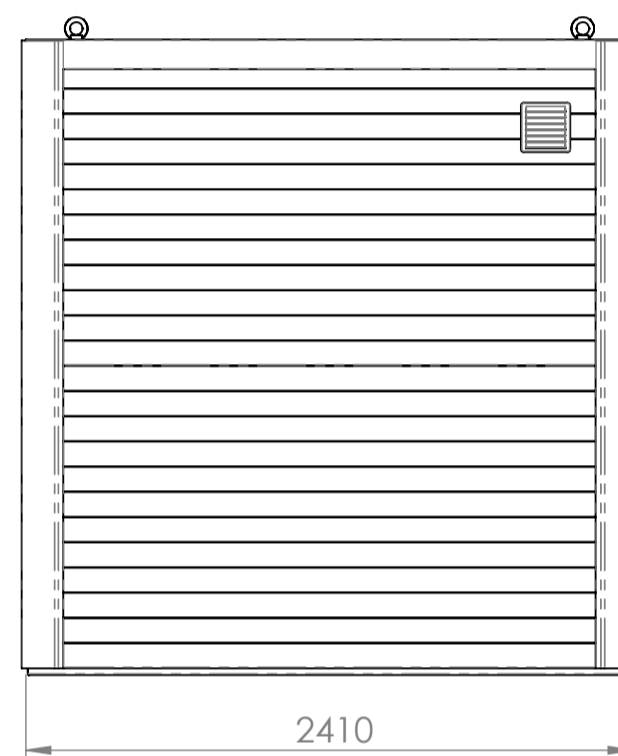
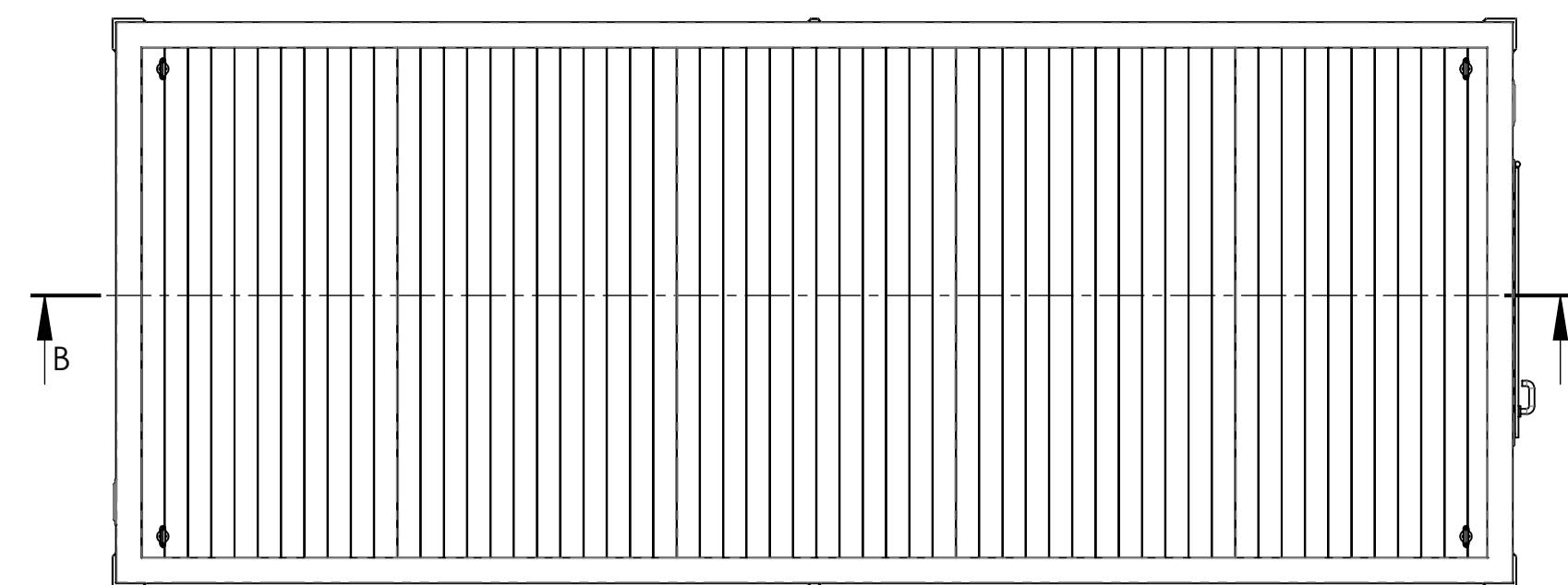

MS-602425
Inwendige afmeting:
(BxDxH) 5840x2250x2240

COPYRIGHT: ZONDER TOESTEMMING VAN HILTRA BARNEVELD IS VERSPREIDING IN WELKE VORM DAN OOK VERBODEN		Tenzij anders vermeld: Maten in mm	
Project: MS serie		Toleranties volgens DIN 7168-M	
Onderwerp: MS6 unit 6000x2410x2630		Wijziging rapport nr.	Tek. nr.: MS6-60-SA-A242
		REV.: A	18-12-2014
		Offertenr.:	...
		Ordernr.:	...
		Hiltra Barneveld B.V. Compagnieweg 14-16 3771 NH BARNEVELD	Tel.: 0342-404160 Fax.: 0342-404169 www.hiltra.com
Formaat:	A1	Schaal:	1:30
Sheet:	1/2	Getekend:	JB 4-9-2014